



European Cup Juniors Leibnitz 2014

leibnitz AUT, 31 May - 01 June 2014)

-44 kg

15 Judoka

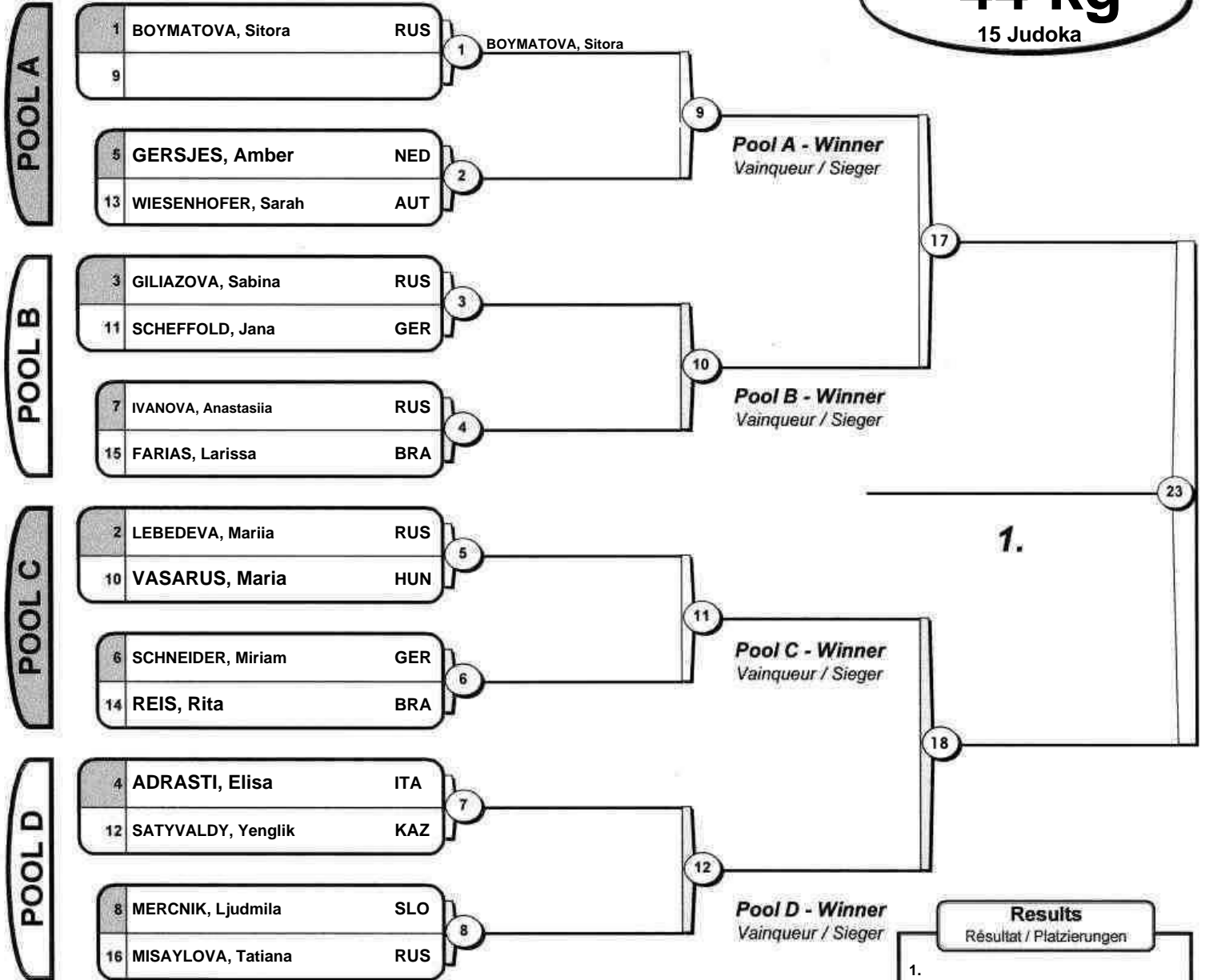

Results	
Résultat / Platzierungen	
1.	
2.	
3.	
3.	
5.	
5.	
7.	
7.	

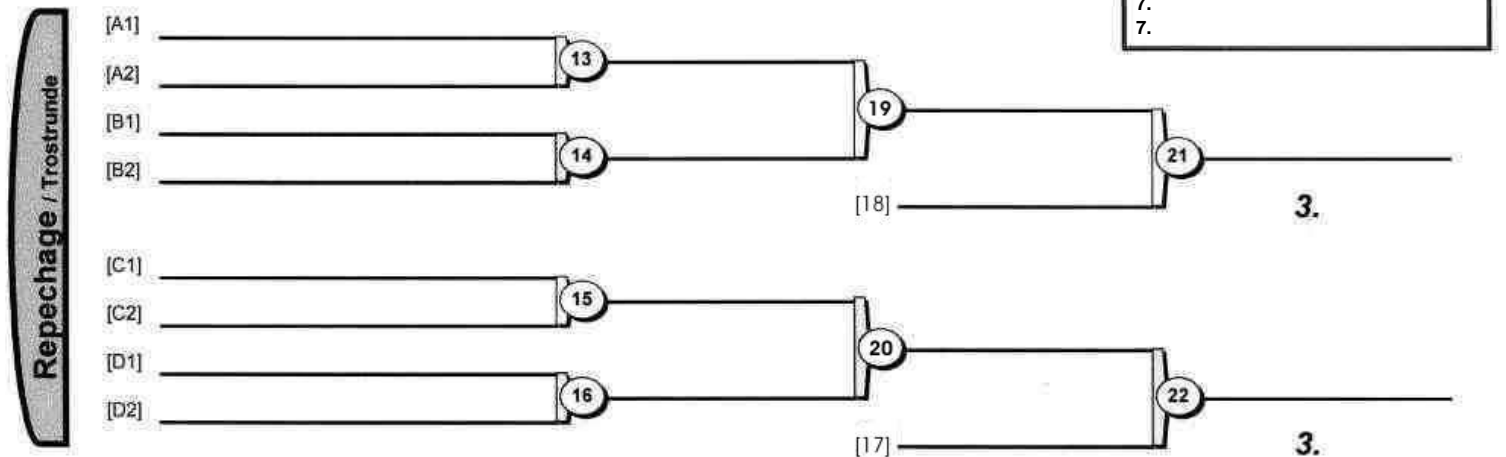



European Cup Juniors Leibnitz 2014

leibnitz AUT, 31 May - 01 June 2014)

-48 kg

23 Judoka

POOL A

1	PASHINA, Anna	RUS	1	PASHINA, Anna
17				17
9	KRAFT, Mara Tabea	AUT	2	
25	ROMANO, Sara Maria	ITA		
5	RASINSKA, Maja	POL	3	RASINSKA, Maja
21				18
13	RIEHL, Maike	GER	4	
29	HLADOVA, Michaela	SVK		

Pool A - Winner
Vainqueur / Sieger

POOL B

3	BOBRIKOVA, Daria	RUS	5	BOBRIKOVA, Daria
19				19
11	NEUBAUER, Pamela-Denise	AUT	6	
27	AYMARD, Virginia	FRA		
7	DEMINTSEVA, Evgeniya	RUS	7	DEMINTSEVA, Evgeniya
23				20
15	SILVA, Tawany	BRA	8	
31	BAUMANS, Marine	BEL		

Pool B - Winner
Vainqueur / Sieger

POOL C

2	NIKOLIC, Milica	SRB	9	NIKOLIC, Milica
18				21
10	STEPANOVA, Elizaveta	RUS	10	
26	AUDIENS, Evelyne	BEL		
6	HEBERLE, Ana	SLO	11	HEBERLE, Ana
22				22
14	LHENRY, Marine	FRA	12	LHENRY, Marine
30				

Pool C - Winner
Vainqueur / Sieger

POOL D

4	KAISER, Nicole	AUT	13	KAISER, Nicole
20				23
12	MERCADANTE, Nathalia	BRA	14	
28	SEIFERT, Jasmine	GER		
8	STANGAR, Marusa	SLO	15	STANGAR, Marusa
24				24
16	PASSA, Romina	ITA	16	
32	MIKONKIKH, Anastasia	RUS		

Pool D - Winner
Vainqueur / Sieger

1.

Results
Résultat / Platzierungen

- 1.
- 2.
- 3.
- 3.
- 5.
- 7.
- 7.

Repechage / Trostrunde

[A1]					
[A2]		29		33	
[B1]			[A3]		
[B2]		30		34	
[B3]			[B3]		
[C1]					[38]
[C2]		31		35	
[D1]			[C3]		
[D2]		32		36	
[D3]			[D3]		
					[41]
					[42]
					[37]

3.

3.



European Cup Juniors Leibnitz 2014

leibnitz AUT, 31 May - 01 June 2014)

-52 kg

36 Judoka

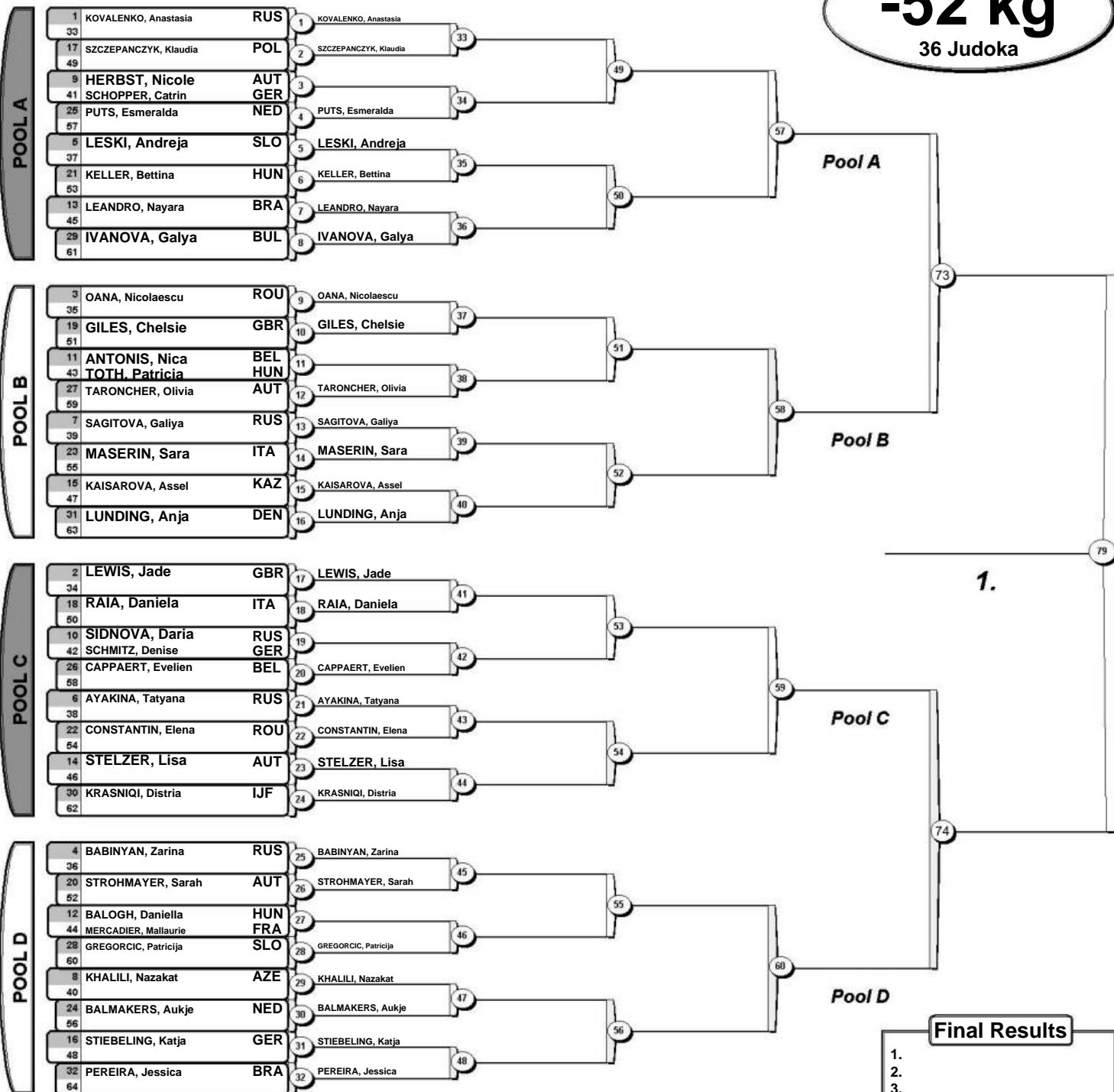

Repechage

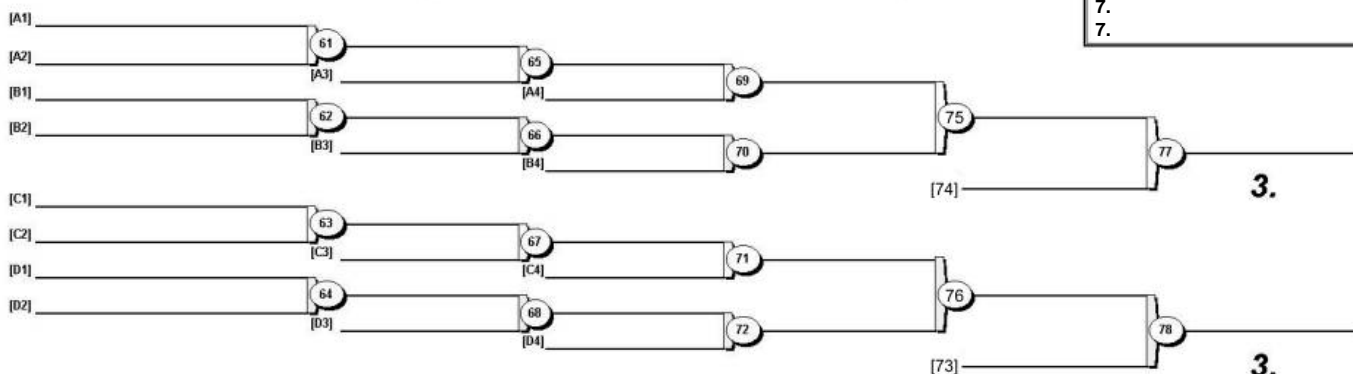



European Cup Juniors Leibnitz 2014

leibnitz AUT, 31 May - 01 June 2014)

-57 kg

44 Judoka

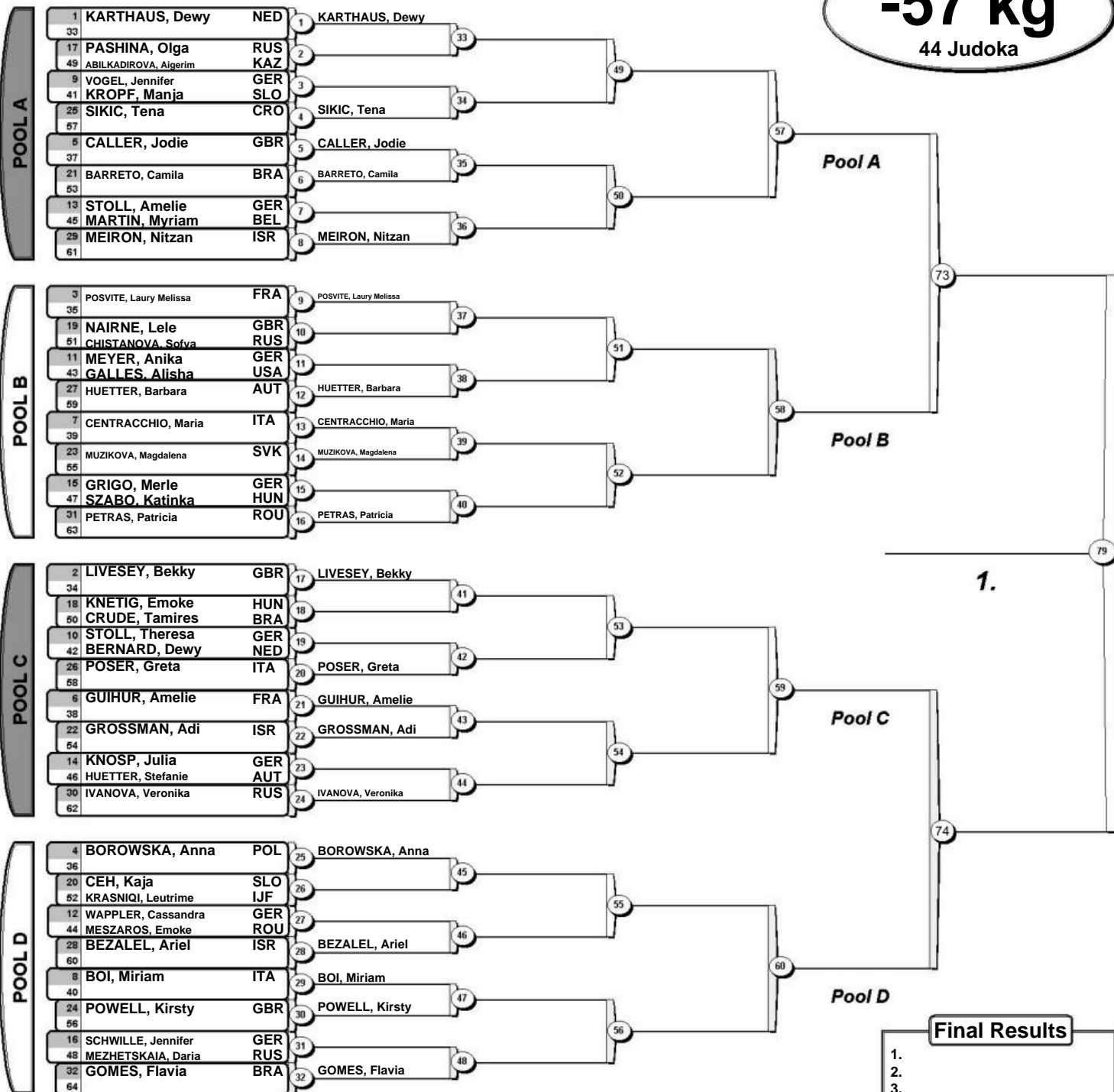

Repechage

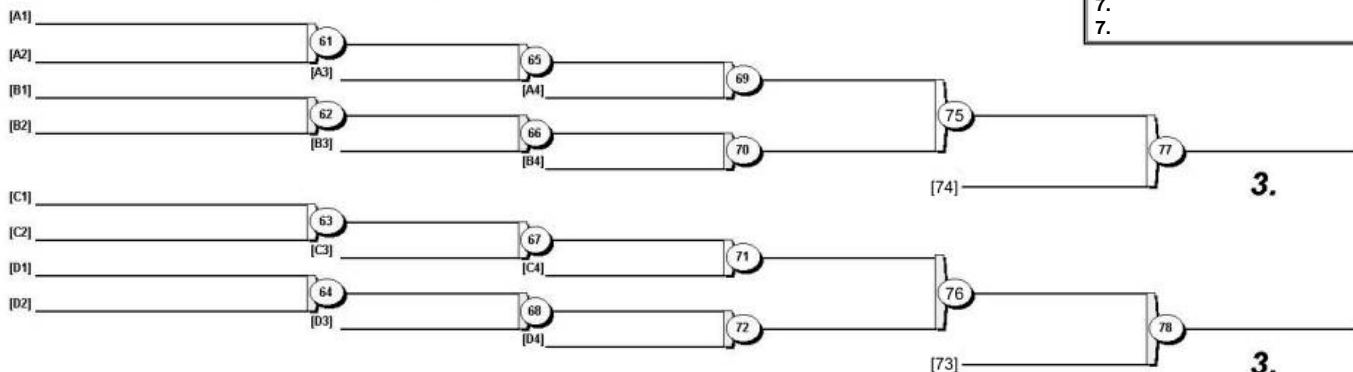



European Cup Juniors Leibnitz 2014

leibnitz AUT, 31 May - 01 June 2014)

-55 kg

32 Judoka

POOL A

1	MAHARRAMOV, Sadikh	AZE	1	MAHARRAMOV, Sadikh	
17	LIM, Vladislav	BEL		100 / 000 s1	1:35
9	LIMA JUNIOR, Luiz Claudio	BRA	2	KHONTIAN, Nikolay	
25	KHONTIAN, Nikolay	RUS		000 s2 / 010 s1	0:0
5	SEIDUALY, Assylzhan	KAZ	3	SEIDUALY, Assylzhan	
21	SAIDOUN, Karim	FRA		100 s3 / 000 s4	0:9
13	VAN ZEIJL, Koen.	NED	4	STARKEL, David	
29	STARKEL, David	SLO		000 / 100	2:40

25 MAHARRAMOV, Sadikh
Pool A - Winner
Vainqueur / Sieger

POOL B

3	ALIPIEV, Valentin	BUL	5	KHUJAMOV, Sobit	
19	KHUJAMOV, Sobit	UZB		000 s1 / 001	0:0
11	PATRICOT, Vincent	FRA	6	WILDNER, Lorenz	
27	WILDNER, Lorenz	AUT		000 / 100	0:0
7	VAN LEERDAM, Timo	NED	7	ZAIRBEKOV, Gamzat	
23	ZAIRBEKOV, Gamzat	RUS		010 s1 / 011 s2	0:0
15	BATISSE, Thibault	FRA	8	MAIGUMA, Kenta	
31	MAIGUMA, Kenta	JPN		000 s2 / 102 s1	0:32

26 ZAIRBEKOV, Gamzat
Pool B - Winner
Vainqueur / Sieger

POOL C

2	KOFFIJBERG, Roy	NED	9	KOFFIJBERG, Roy	
18	BORCHASHVILLI, Adam	AUT		100 / 000 s1	2:22
10	FIKRI, Kamal	FRA	10	FIKRI, Kamal	
26	FREITAS, Jonathan	BRA		001 s3 / 000 s2	0:0
6	ABREU, Brian	USA	11	GOLOVKO, Alexandr	
22	GOLOVKO, Alexandr	RUS		000 / 100	3:25
14	GARD, Richard	HUN	12	KHALILOV, Mehman	
30	KHALILOV, Mehman	AZE		000 s1 / 001	0:0

27 KOFFIJBERG, Roy
Pool C - Winner
Vainqueur / Sieger

POOL D

4	LOMBARDO, Manuel	ITA	13	RUZIEV, Doston	
20	RUZIEV, Doston	UZB		000 s1 / 000	0:0
12	TATTIBAY, Didar	KAZ	14	FERRIEUX, Hugo	
28	FERRIEUX, Hugo	FRA		000 s2 / 001 s1	0:0
8	SOLOMGERIEV, Magomed	RUS	15	SOLOMGERIEV, Magomed	
24	DI MARCA, Flavio	BEL		001 / 000 s3	0:0
16	HAESSNER, Fabian	GER	16	VAN HARTEN, Matthijs	
32	VAN HARTEN, Matthijs	NED		000 s3 / 000 s1	0:0

28 SOLOMGERIEV, Magomed
Pool D - Winner
Vainqueur / Sieger

MAHARRAMOV, Sadikh
002 / 001 s1 0:0

1.

38 KOFFIJBERG, Roy
100 / 000 3:36

Results
Résultat / Platzierungen

1. MAHARRAMOV, Sadikh AZE
2. KOFFIJBERG, Roy NED
3. SEIDUALY, Assylzhan KAZ
3. ZAIRBEKOV, Gamzat RUS
5. SOLOMGERIEV, Magomed RUS
5. FIKRI, Kamal FRA
7. VAN LEERDAM, Timo NED
7. DI MARCA, Flavio BEL

Repechage / Trostrunde

[A1]	LIM, Vladislav	BEL	29	KHONTIAN, Nikolay	
[A2]	KHONTIAN, Nikolay	RUS		000 s3 / 101 s1	2:28
[B1]	VAN LEERDAM, Timo	NED	[A3]	SEIDUALY, Assylzhan	
[B2]	MAIGUMA, Kenta	JPN		000 s1 / 110 s2	0:35
[C1]	BORCHASHVILLI, Adam	AUT	30	VAN LEERDAM, Timo	
[C2]	FIKRI, Kamal	FRA		100 s2 / 000 s4	1:25
[D1]	DI MARCA, Flavio	BEL	[B3]	WILDNER, Lorenz	
[D2]	VAN HARTEN, Matthijs	NED		000 / 000 s1	0:0
			[C3]	GOLOVKO, Alexandr	
				000 s1 / 000 s2	0:0
			32	DI MARCA, Flavio	
				001 s1 / 000 s3	0:0
			[D3]	RUZIEV, Doston	
				010 s1 / 000 s1	0:18

[38] SOLOMGERIEV, Magomed

3.

[37] ZAIRBEKOV, Gamzat

3.



European Cup Juniors Leibnitz 2014

leibnitz AUT, 31 May - 01 June 2014)

-60 kg

52 Judoka

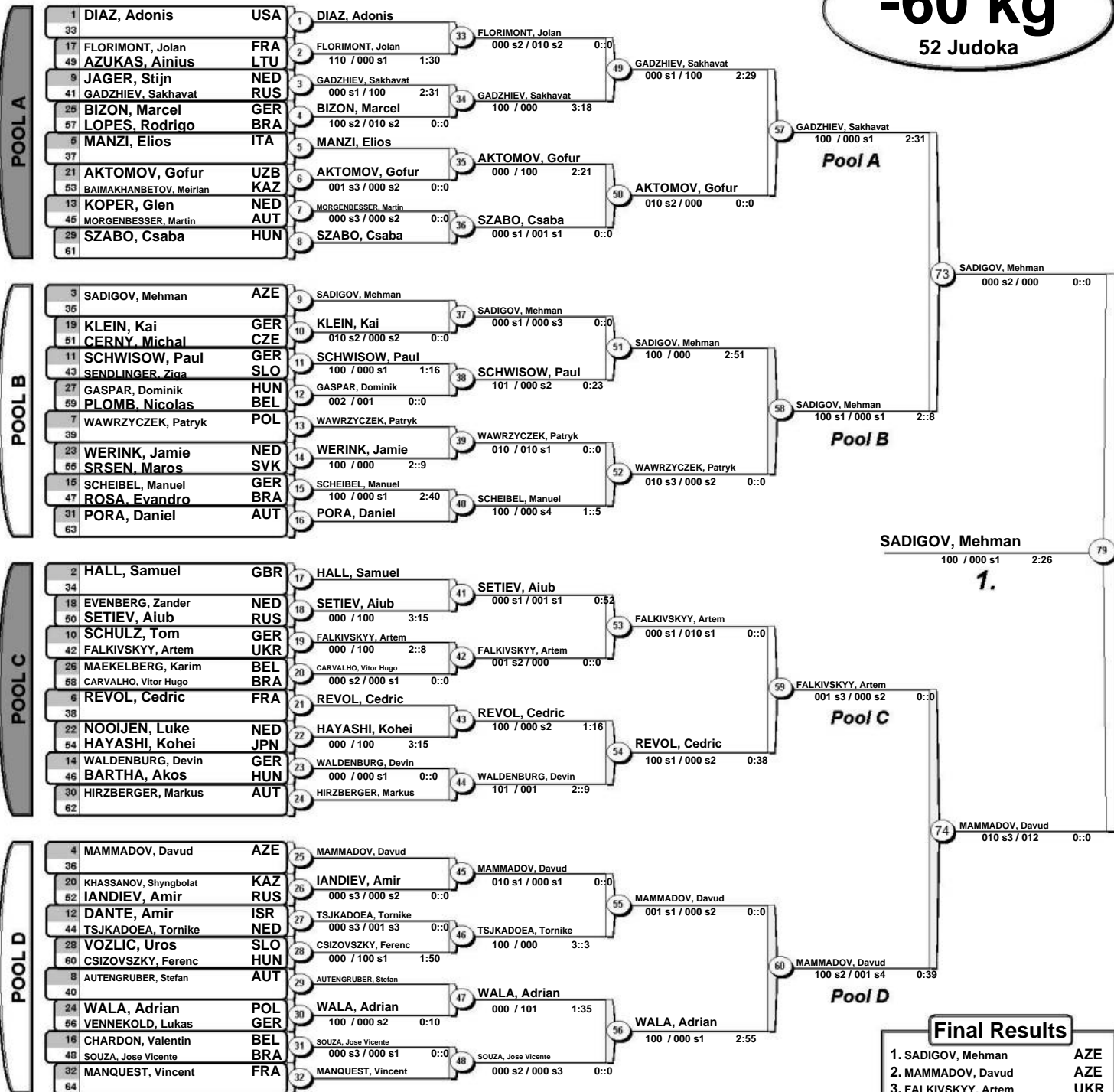

Repechage





European Cup Juniors Leibnitz 2014

leibnitz AUT, 31 May - 01 June 2014)

A/B

-66 kg
72 Judoka

POOL A

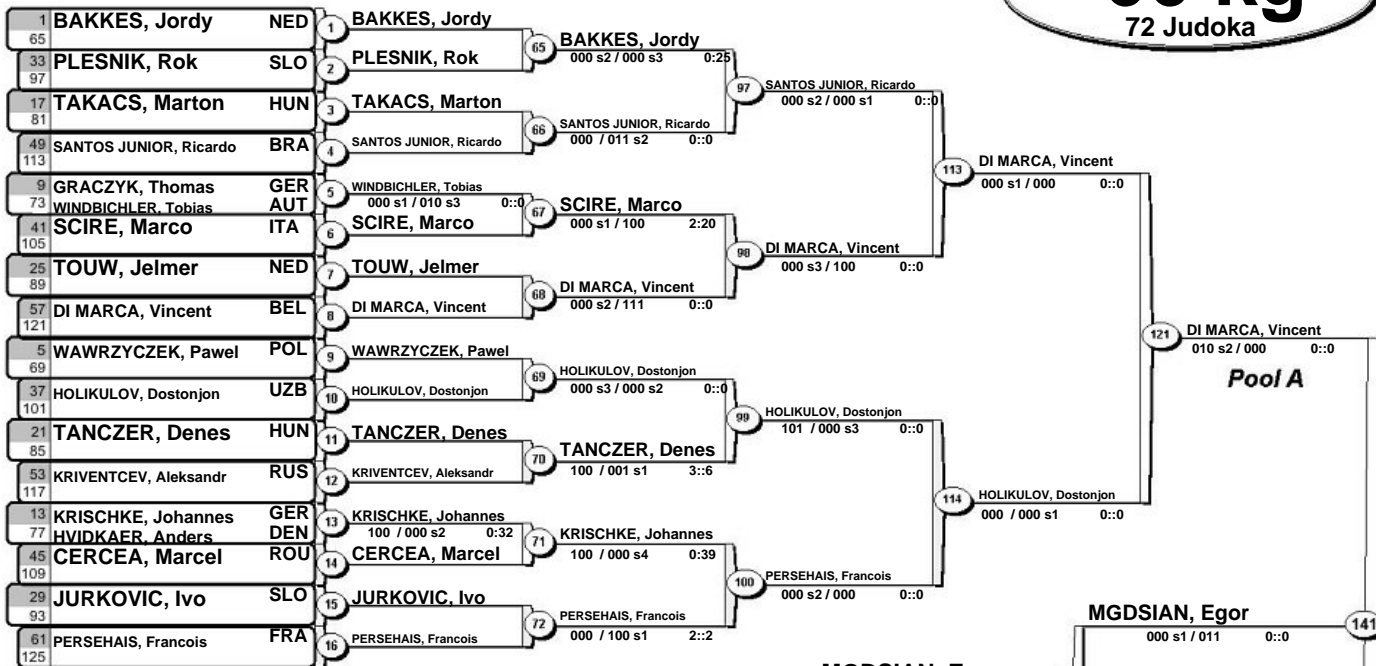

POOL B

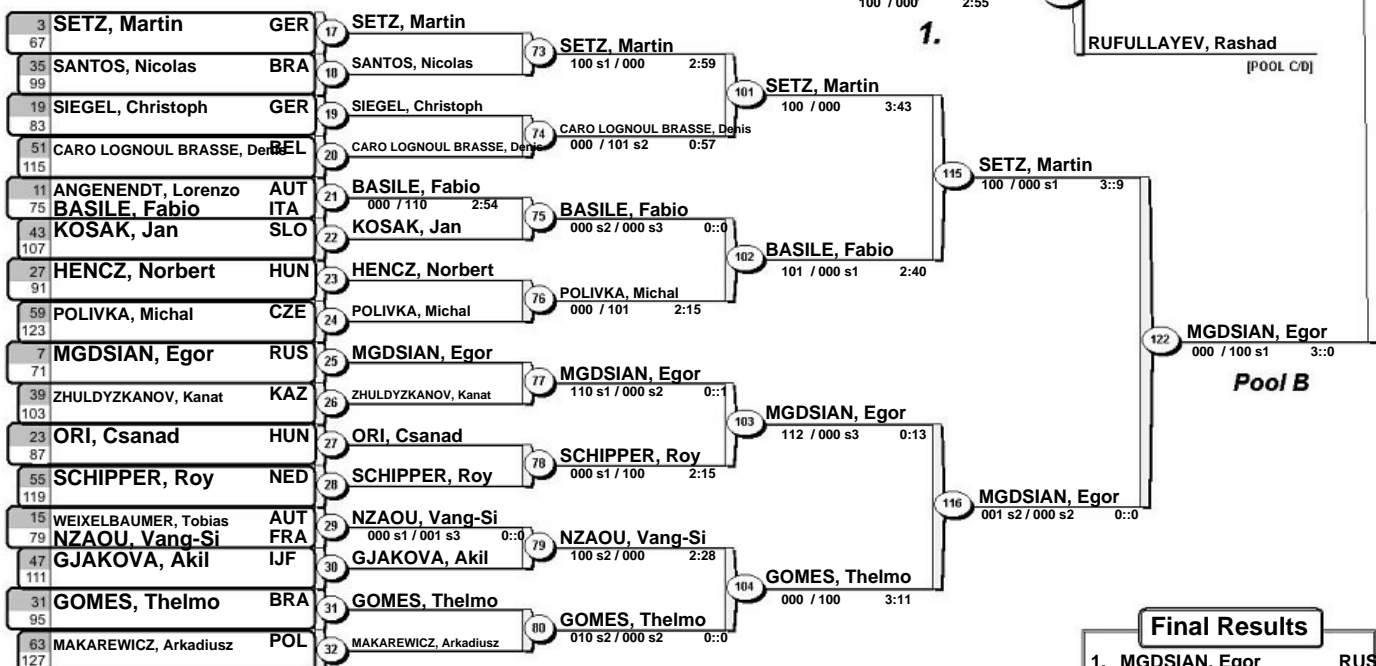

Final Results		
1.	MGDSIAN, Egor	RUS
2.	RUFULLAYEV, Rashad	AZE
3.	SETZ, Martin	GER
3.	TURSUNOV, Sukhrob	UZB
5.	KULIKOVSKI, Alexandr	RUS
7.	DI MARCA, Vincent	BEL
7.	HOLIKULOV, Dostonjon	UZB
7.	STEFANELLI, Biagio	ITA

Repechage

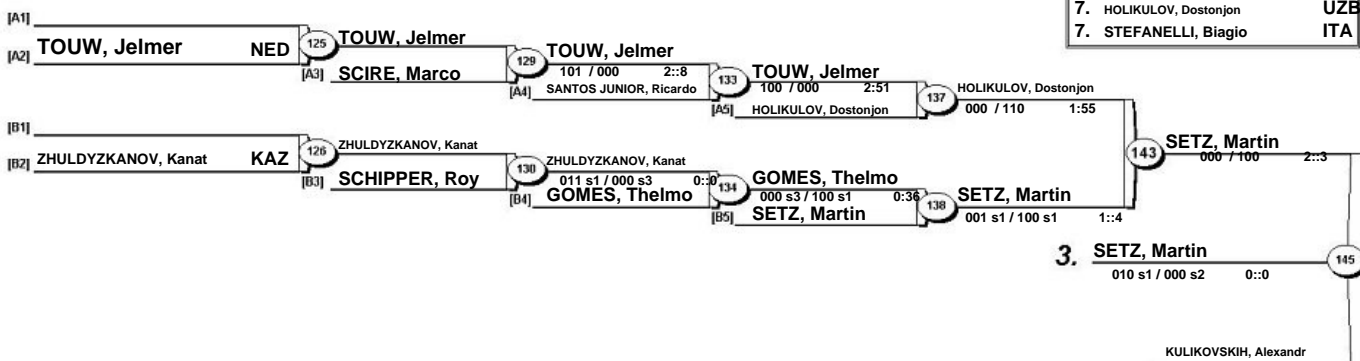



European Cup Juniors Leibnitz 2014

leibnitz AUT, 31 May - 01 June 2014)

C/D

-66 kg
72 Judoka

POOL C

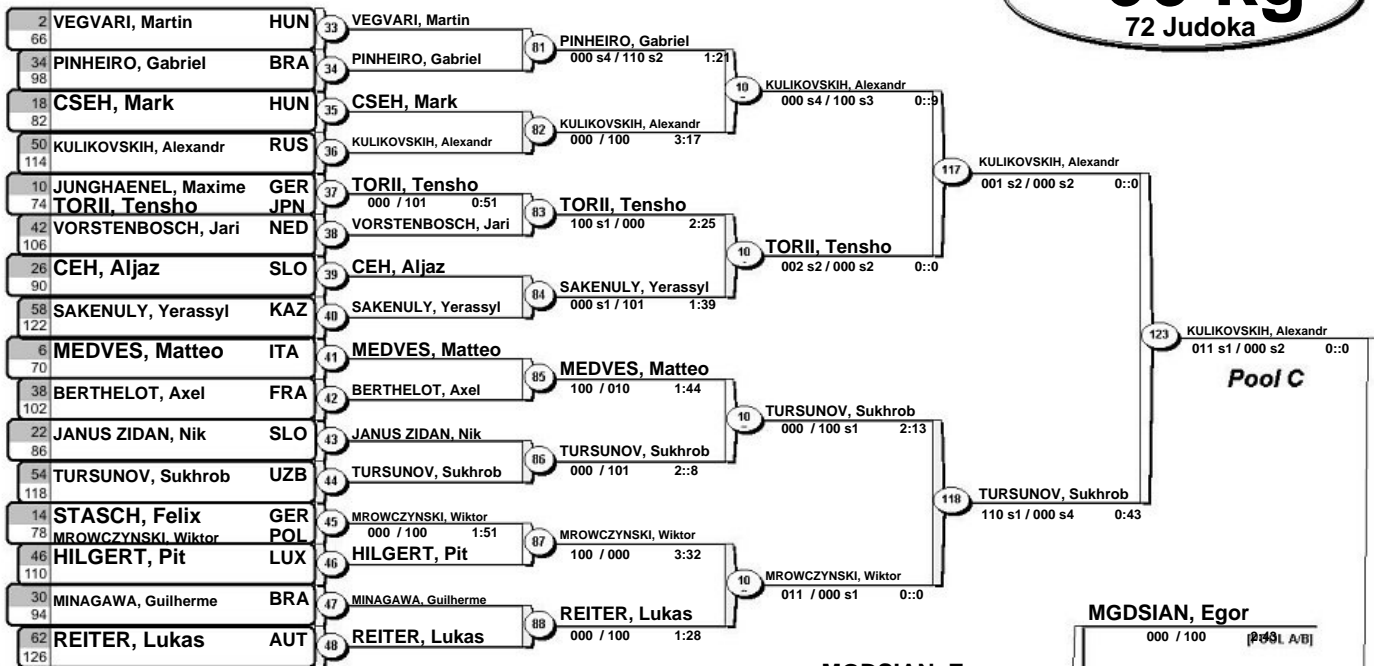

POOL D

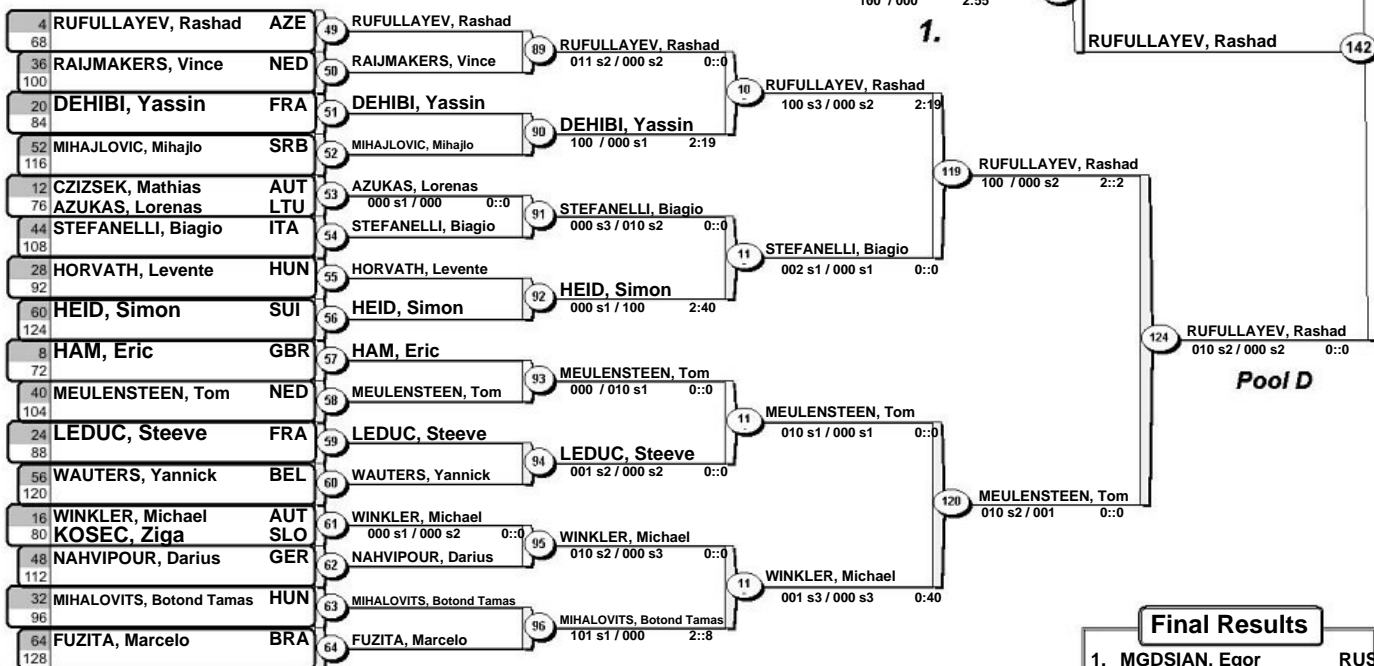

Final Results		
1.	MGDSIAN, Egor	RUS
2.	RUFULLAYEV, Rashad	AZE
3.	SETZ, Martin	GER
3.	TURSUNOV, Sukhrob	UZB
5.	KULIKOVSKI, Alexandr	RUS
7.	DI MARCA, Vincent	BEL
7.	HOLIKULOV, Dostonjon	UZB
7.	STEFANELLI, Biagio	ITA

Repechage

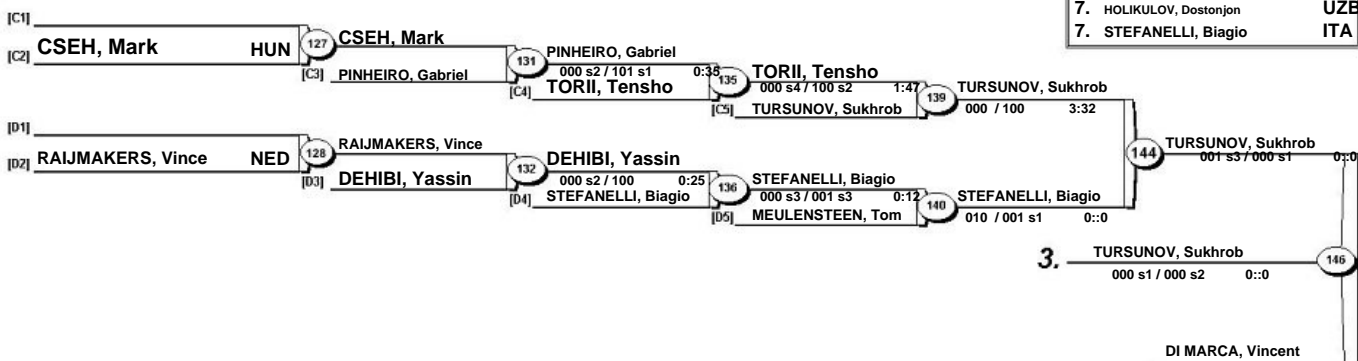



European Cup Juniors Leibnitz 2014

leibnitz AUT, 31 May - 01 June 2014)

-73 kg

61 Judoka

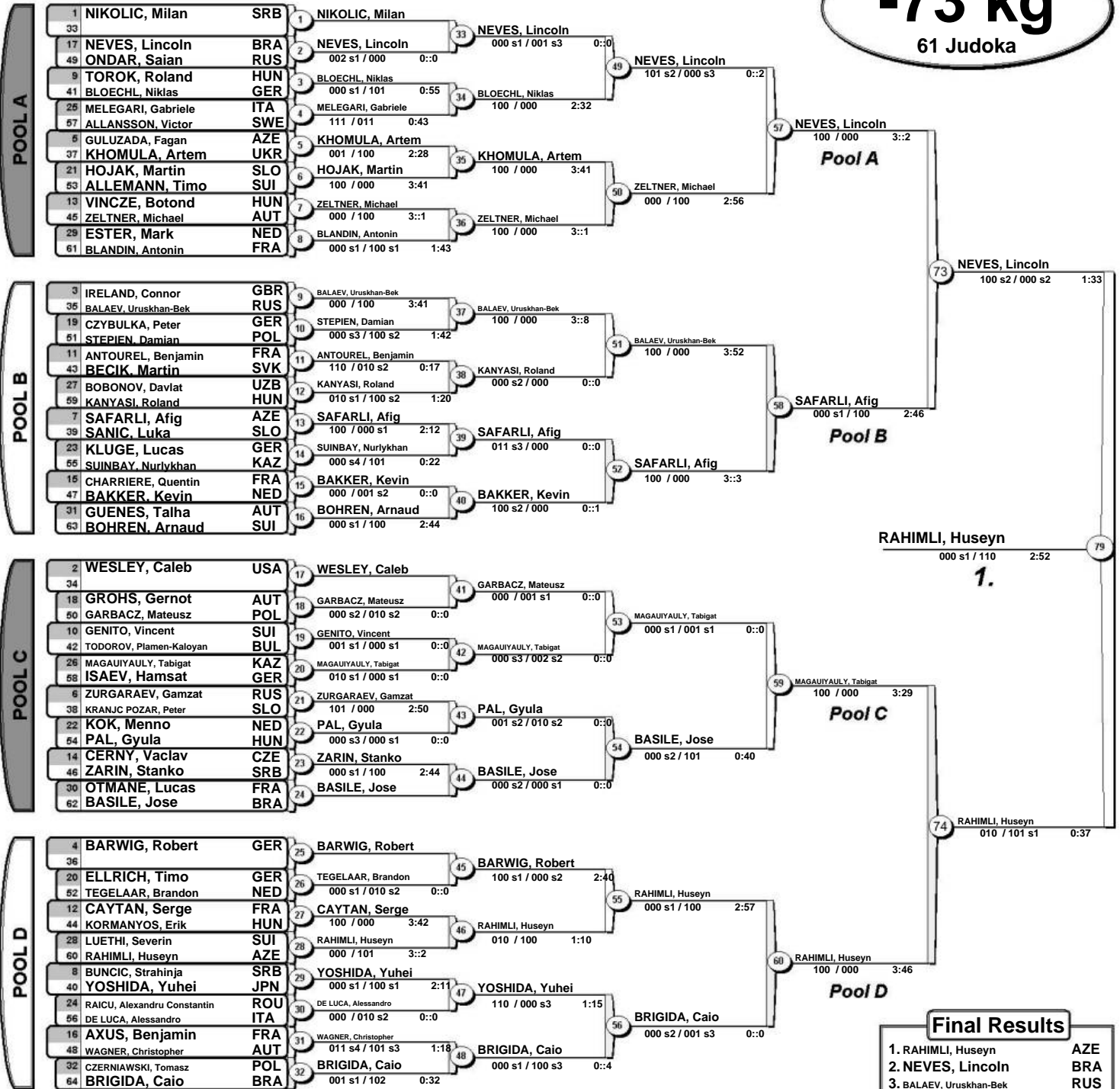

Repechage

